

INSTALLATION GUIDE – 240 kW

Model(s) : TP5-240-480/HPC-240-480

DC quick charging stations Installation and operating instructions.

Please read all the instructions before installation and save them for future reference.



MANY THANKS!

Dear customer!

Thank you for purchasing this ChargeTronix product. Before using or operating this product, please read this manual carefully and keep it handy. The company is not liable for any accidents caused by breach of safety precautions or instructions in this manual. This product is live and should only be opened by instructed service personnel or a qualified electrician for service, maintenance or repair and fault handling to avoid electric shock.

ATTENTION

Our company will not assume any responsibility for power damage, personal injury, property loss or damage of charger caused by installation not in accordance with the instructions of this manual.

PLEASE NOTE

ChargeTronix reserves the right to make change as necessary to comply with change in the industry and due to errors and omissions to ensure a safe and reliable installation.

Please call our customer support line if there are any questions related to installation or operation of this equipment.

"Please don't make assumptions, call us!"

CONFIDENTIALITY

The materials contained in this document represent proprietary and confidential information pertaining to services and methods of ChargeTronix. By reading this document you agree that the information shall not be disclosed outside of and shall not be duplicated, used, or disclosed for any purpose other than what it was created for.

This manual covers the electrical and mechanical installation procedure for the ChargeTronix TP5-240-480/HPC-240-480 charger. The operations and programming manual are separate. The model hosts different voltage and connector configurations. Below are different product numbers.

TP5-240-480-2-300	Max Voltage:1000VDC; Connectors: Dual CCS1 300A (Nominal) & 350A (Peak)
HPC-240-480-1	Max Voltage: 1000VDC; Connectors: Liquid Cooled CCS1 and CHAdeMO
HPC-240-480-2	Max Voltage:1000VDC; Connectors: Dual Liquid Cooled CCS1
HPC-240-480-3	Max Voltage: 1000VDC; Connectors: Liquid Cooled CCS1 and Liquid Cooled NACS
HPC-240-480-4	Max Voltage: 1000VDC; Connectors: Dual Liquid Cooled NACS

TABLE OF CONTENTS

TABLE OF CONTENTS	03
CRITICAL SAFETY	05
SPECIFICATIONS	08
ADAPTED GRID SYSTEM	10
INSTALLATION OVERVIEW	11
ADA CONSIDERATION	13
RECOMMENDED CABLE GAUGE	14
BOX CONTENTS	15
OUTLINE OF DRAWING	16
STATION ANATOMY	20
MECHANICAL INSTALLATION	23
UNPACK	25
START INSTALLATION	26
WIRING	30

TABLE OF CONTENTS

PREPARATIONS BEFORE STARTING	32
OPERATING INSTRUCTIONS	34
CHARGER SETTINGS	35
HOW TO START A CHARGING SESSION	51
MAINTENANCE AND SERVICE	53
TROUBLESHOOTING	55
CUSTOMER RESPONSIBILITIES	58
WARRANTY AND SERVICE PLAN	59
WARRANTY TERMS	59
EXCLUSIONS FROM LIMITED WARRANTY	60
CONTACT US	62



CRITICAL SAFETY READ THE ENTIRE MANUAL BEFORE DESIGNING OR INSTALLING EQUIPMENT

! WARNING

This unit is a high-powered electrical device and can be hazardous if improperly installed, serviced, or operated. Failure to follow procedures in this manual could result in extreme hazard to personnel and/or damage to the equipment and related infrastructure. In addition, the installation, service, and maintenance need to comply with local codes and the Authority Having Jurisdiction (AHJ).

! IMPORTANT SAFETY INSTRUCTIONS

The symbols used are international icons used to depict various levels of caution when installation, servicing or maintaining the equipment. Same symbols will also appear on the equipment for identifying caution levels required when accessing certain areas of the charger.

	DANGER	High voltage danger label to keep people safe from electrical discharge, which could result in injury or potential death.
	WARNING	Warning icon represents hazard, that could result in severe injury or possibly death.
	GENERAL CAUTION	Caution icon represents a potential hazard or unsafe practice that could result in injury.

CRITICAL SAFETY READ THE ENTIRE MANUAL BEFORE DESIGNING OR INSTALLING EQUIPMENT

! SERVICE WARNING

There are no serviceable items inside the equipment. There is high voltage inside the equipment which could cause severe injury or death. Do not attempt to repair the charge station yourself. This can only be performed by factory qualified personnel.

! CHARGING CABLE DAMAGE

Do not operate the charger if the charging cable is damaged or if there are exposed wires in the charging cord assembly. Shut off power at the electrical disconnect or at the breaker. Then immediately contact ChargeTronix service. If there are any questions, please contact customer service.

! SAFETY INSTRUCTIONS

Read the entire installation instructions before designing the installation and prior to installation. This equipment should be installed by a journeyman level electrician. Local building codes need to be complied with. In most jurisdictions the installation of this equipment requires plan check, building and electrical permits. Verify with the local Authority Having Jurisdiction prior to starting construction.

The charging station relies on the grounding system for safety. All grounding instructions should be strictly adhered to as prescribed in this manual and any applicable electrical safety requirements, all local electrical safety codes, and NEC.

CRITICAL SAFETY READ THE ENTIRE MANUAL BEFORE DESIGNING OR INSTALLING EQUIPMENT**! HIGH VOLTAGE EQUIPMENT:**

This charging system contains both AC and DC high voltage circuitry and devices and should only be installed by a qualified electrician trained to work on high voltage, high current AC and DC systems.

! ADDITIONAL CAUTIONARY NOTES**WARNING**

Do not have power on while any of the maintenance doors are open unless proper personnel protection equipment is worn.

Only trained personnel should be working in this equipment while the doors are open, and the unit is powered on.

WARNING

There are high voltage and high-capacity energy storage components on this system. There are components and circuits that remain charged for some time (1 to 2 minutes) with high voltage power, even after main power is disconnected. Always test with a voltmeter before any maintenance or service is performed.

Only ChargeTronix authorized personnel are allowed to perform product repairs.

Power		TP5-240-480	HPC-240-480
Maximum Power		240 kW	
Output Voltage		150 – 1000VDC	
Max Output Current		Up to 800A	
Input Voltage Frequency		480VAC (3P + N + PE) 60Hz	
FLA Breaker Rating		320A 400A	
Rated Power		265.7kVA	
Power Factor		> 0.98 @ full load	
Efficiency		> 94% at nominal power output	
Connectors		TP5-240-480	HPC-240-480
Connector Options		CCS1 CHAdeMO NACS	
CCS Cable		Standard up to 300A (Nominal) & 350A (Peak) – Air Cooled	Up to 500A – Liquid Cooled
CHAdeMO Cable		Standard up to 125A – Air Cooled Optional up to 200A – Air Cooled	
NACS Cable		Up to 400A – Air Cooled	Up to 600A – Liquid Cooled
Cycle Mode		1 x 240kW (Max: 400A)	1 x 240kW (Max: 600A)
Parallel Mode		2 x 120kW (Max: 800A)	
Charging Protocol		Mode 4, IEC-61851, ISO-15118, DIN SPEC 70121 Mode 4, CHAdeMO 0.9, 1.0	
Connector Cable Length		CCS – 13ft (4m) CHAdeMO & NACS – 16ft (5m) Cable Management included for all connectors	

Charger Properties	TP5-240-480	HPC-240-480
Weight	1272lbs (577kg)	1190lbs (540kg)
Dimensions (L x D x H)	51.81" x 40.71" x 77.16"	43.07" x 36.97" x 81.30"
Display	10" LCD touch screen	
Ingress Protection	NEMA 3S (IP54), IK 10	
Altitude	< 6,600ft (2,000m)	
Operating Temperature	-20°C to 55°C (-4°F to 131°F)	
Working Storage Humidity	≤ 95% RH ≤ 99% RH (Non-condensing)	
Insulation (input – output)	> 2.5kV	
Interface Protocol	OCPP 1.6J	
Access Control	RFID: ISO/IEC 14443A/B Credit Card Reader – Optional	
Power Electronics Cooling	Air Cooled	

Compliance & Safety	TP5-240-480	HPC-240-480
Regulatory Compliance	UL 2202, UL 2231-2 EMC: EN 61000-6-1:2007, EN 61000-6-3:2007/A1:2011/AC:2012	
Communication Protocol	Ethernet, 4G, Wi-Fi	
Electrical Safety: GFCI	RCD 20mA Type A	
Electrical Safety: Surge Protection	20kA	
Electrical Safety: General	Over Voltage, Under Voltage, Over Current, Missing Ground	
Electrical Safety: Output Short	Output power disabled when output is short circuited	
Electrical Safety: Temperature	Temperature Sensors @ Charge Coupler and Power Electronics	
Emergency Stop	Emergency stop button disables output power	
Metering	DC kWh meter per connector	

ADAPTED GRID SYSTEM

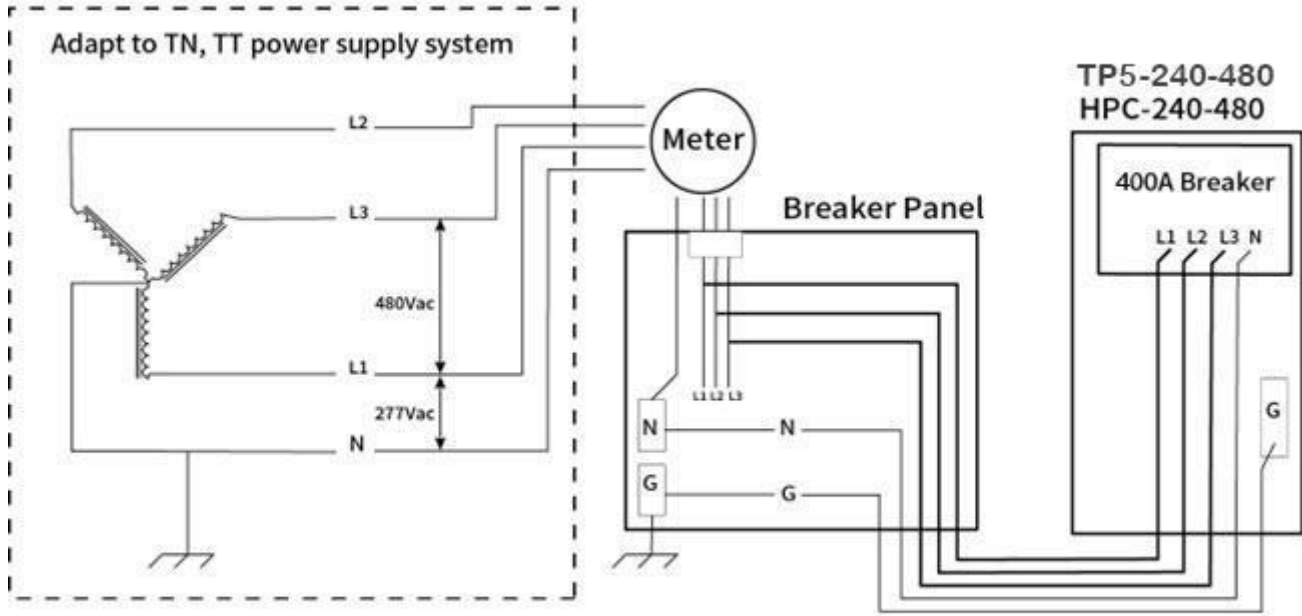

INSTALLATION OVERVIEW

Electrical Input Requirements	Input voltage: 480Y VAC (3 Phase + Neutral + Earth), 60Hz
	Full Load Amperage: 320 Amps (At Rated power)
	Breaker Capacity: 400 Amps
Location	This charging stations has 4 doors, i.e. Front, Rear, Left and Right. Clear 35" distance on the front and rear sides and 24" on left and right side of a charger to be maintained for air circulation for cooling and opening panel for maintenance.
	Flat concrete base with vertical gradient not more than 5% will be provided and a provision for electrical service wires to exit the concrete pad in the location as defined in this document.
	HPC-240-480 Charger Dimensions (L X D X H): 43.07"x 36.97"x 81.30" TP5-240-480 Charger Dimensions (L X D X H): 51.81"x 40.71"x 77.16"
Mounting Pad	Mounting pad shall be of concrete cement with approximate dimensions Length 41.3", Width 41.7", Height 29.6", to accommodate the weight and dimensions of the base. Place the charger on the concrete mounting pad with anchor studs using lock washers and nuts.
	For ADA requirements, the concrete mounting pad shall not exceed 6 inches above the plane of the parking lot.
	For relocation / lifting – Forklift can be used; provision has been made for this.

INSTALLATION OVERVIEW

Barricade (Bollards)	Suitable bollards should be provisioned to restrict approach of EV to the charger. EV shall be at in accordance with local code.
Cables	Input Cables must be Copper (3P+N). Flexible copper is preferred. Please see the table below in next section for the cable gauge.
	Depending on the situation and cable type, the cables must be embedded in the ground with proper cable duct.
Grounding	Reliable protective grounding must be provided. It is recommended to have separate dedicated ground exclusively for the charger considering safety aspects. The ground resistance should be less than or equal to 4Ω. Copper cable in accordance with NEC shall be used to connect charger housing to external ground.
Breaker	Breaker (3P+N) with suitable current capacity depending upon the charger rating to be provided. This shall be in accordance with NEC, typically 1.25 X Full Load Amperage.
Miscellaneous	Copper lugs (flat type) for input cable and earth cable should be provided based on size of cable.

INSTALLATION OVERVIEW

Additional notes	Do not allow flammable or explosive materials, chemicals, flammable vapors, or other dangerous goods close to charging station.
	In the areas of floods, heavy rains, storms, snow, or similar harsh weather conditions, ChargeTronix recommends a canopy for the charger for protection. The charger is IP54.
	Confirm that your installation site has a load capacity sufficient to support this equipment.
	Charge cable length depending on options will be between 13 ft & 16 ft.

ADA CONSIDERATION

This equipment has been designed to meet ADA requirements when installed as prescribed in this manual and in accordance with the STANDARDS FOR ACCESSIBLE DESIGN for Americans with Disabilities document, 2010 ADA Standards for Accessible Design:

http://www.ada.gov/2010ADASTandards_index.htm









Parking space, allowances for wheelchair movement, charger, bollards, and parking stops are defined in several publicly available EV charger installation recommended practices documents incorporating the ADA requirements. <http://www.ada.gov> *For information about the ADA, including the revised 2010 ADA regulations, please visit the Department's website www.ADA.gov; or, for answers to specific questions, call the toll-free ADA Information Line at 800- 514-0301 (Voice) or 800-514-0383 (TTY).

RECOMMENDED CABLE GAUGE

Capacity	FLA(Amps)	Breaker(Amps)	AWG
30kW	40	50	8
60kW	80	100	2
120kW	160	200	3/0
160kW	215	270	300MCM
180kW	240	300	350MCM
200kW	265	335	400MCM
240kW	320	400	600MCM
300kW	400	500	900MCM
360kW	480	600	1500MCM

BOX CONTENTS

Item	Quantity
Charger	1
Bolt M14 *100	6
Charging Card	3
Key	2
Factory Test Report	1
Matching socket or hex wrench (Match according to the molded case circuit breaker model)	1
Certificate	1

Bolt M14 *100	Matching socket or hex wrench
	
Charging Card	
	Certificate
Key	
	Factory Test Report
	

OUTLINE OF DRAWING (HPC-240-480)

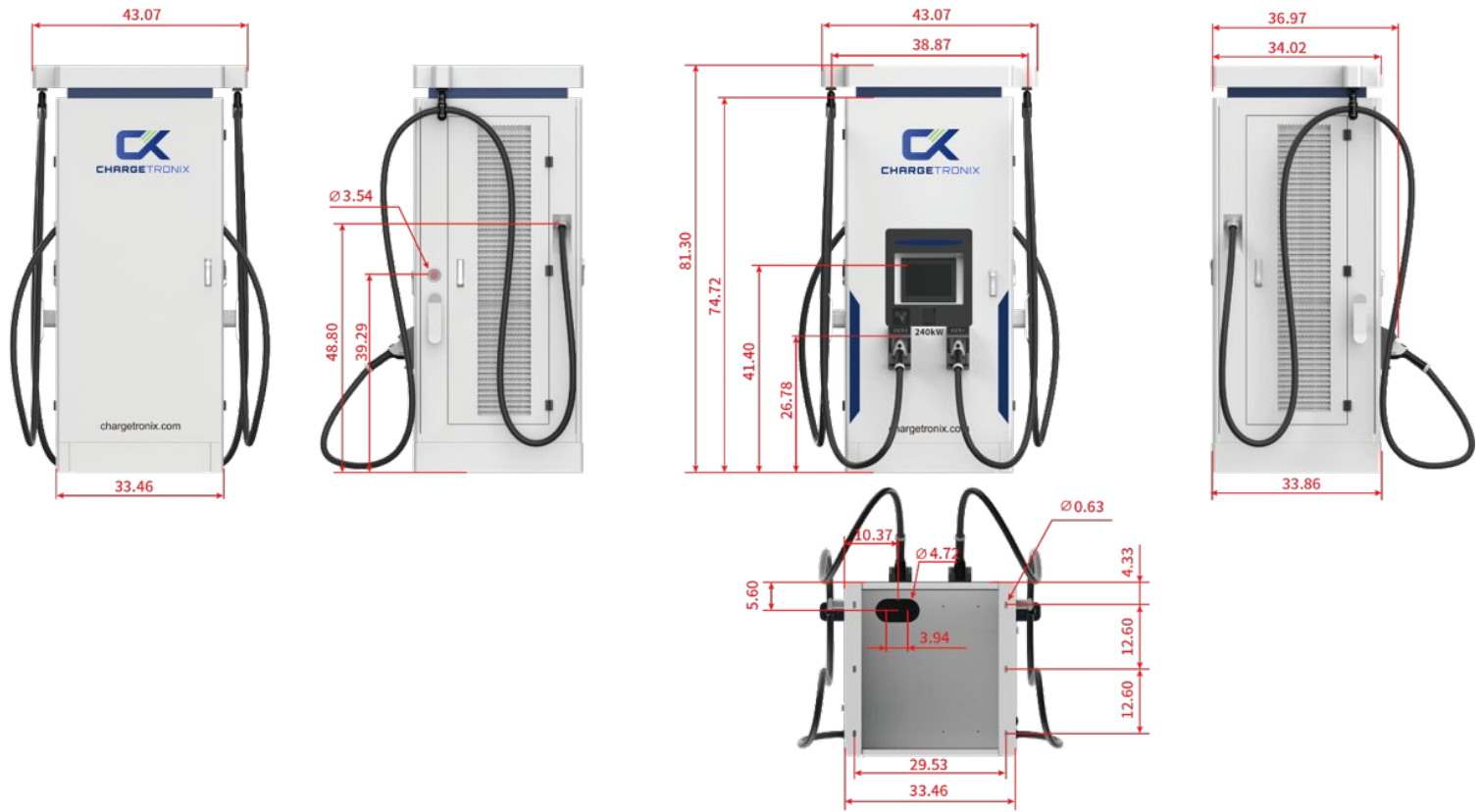

OUTLINE OF DRAWING (HPC-240-480)

Before making the concrete pad, determine the position of the pre-embedded PVC pipe according to the position shown in the figure to facilitate later wiring.

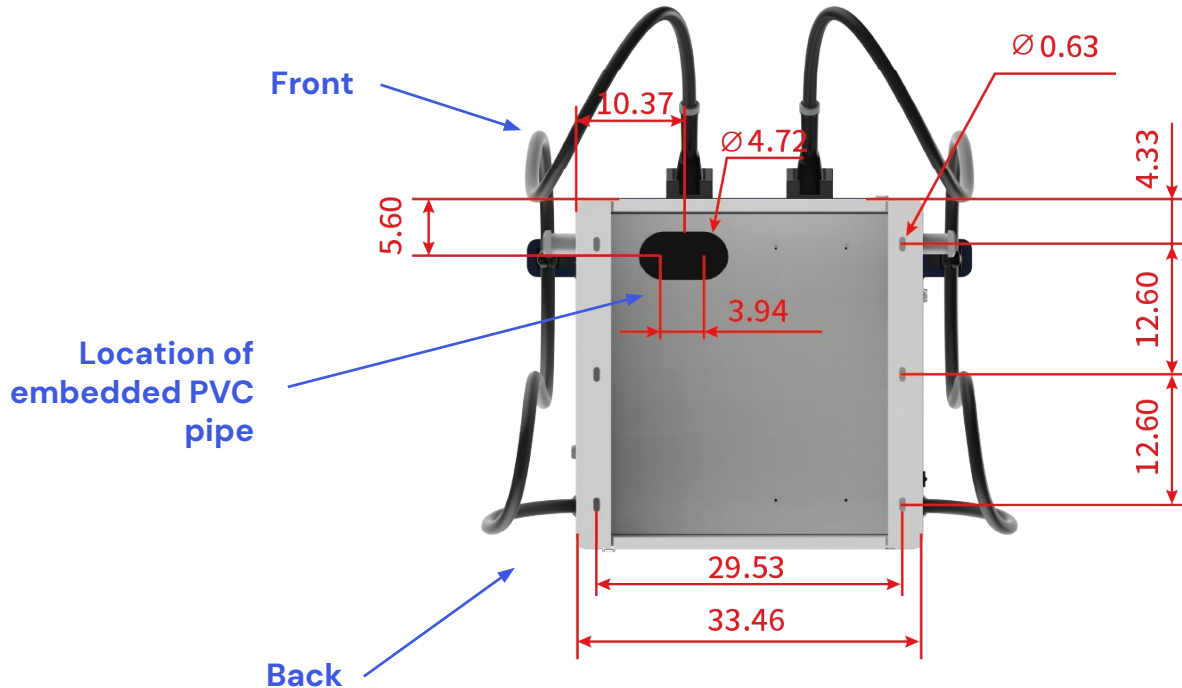

STATION ANATOMY

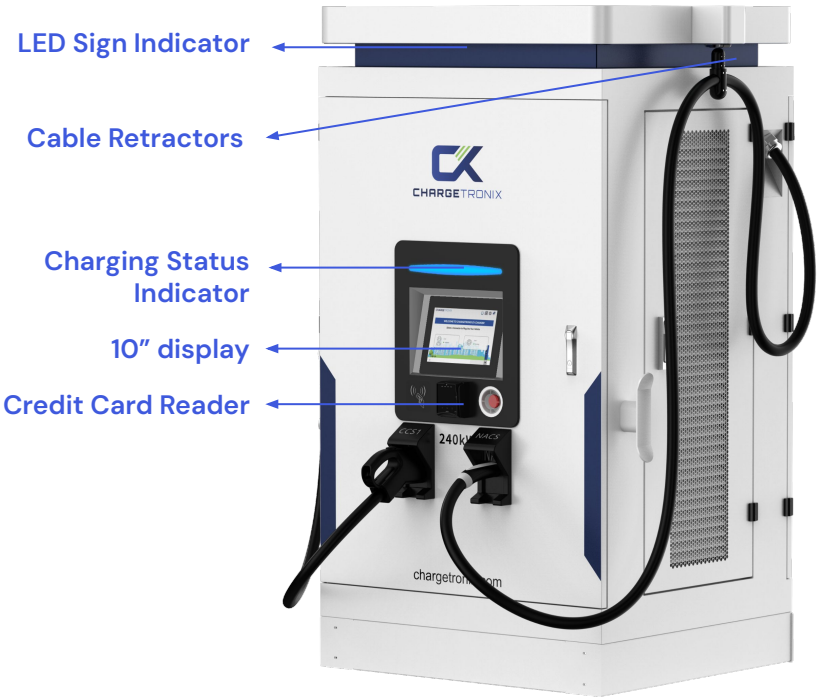

STATION ANATOMY

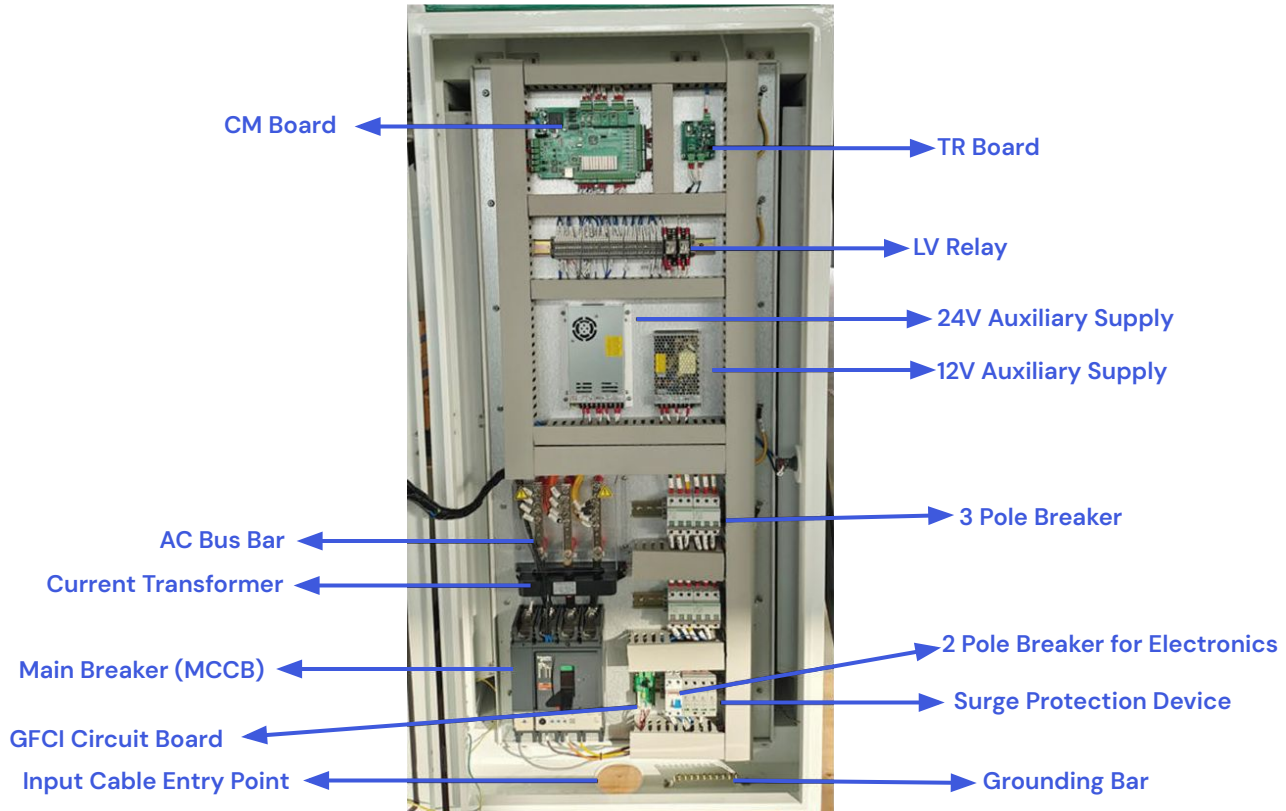

STATION ANATOMY

- Pos Machine Antenna
- 4G Modem Antenna
- 4G Modem
- X86/Computer
- LED Panel
- Screen
- Pos Machine
- RFID Reader



MECHANICAL INSTALLATION (HPC-240-480)

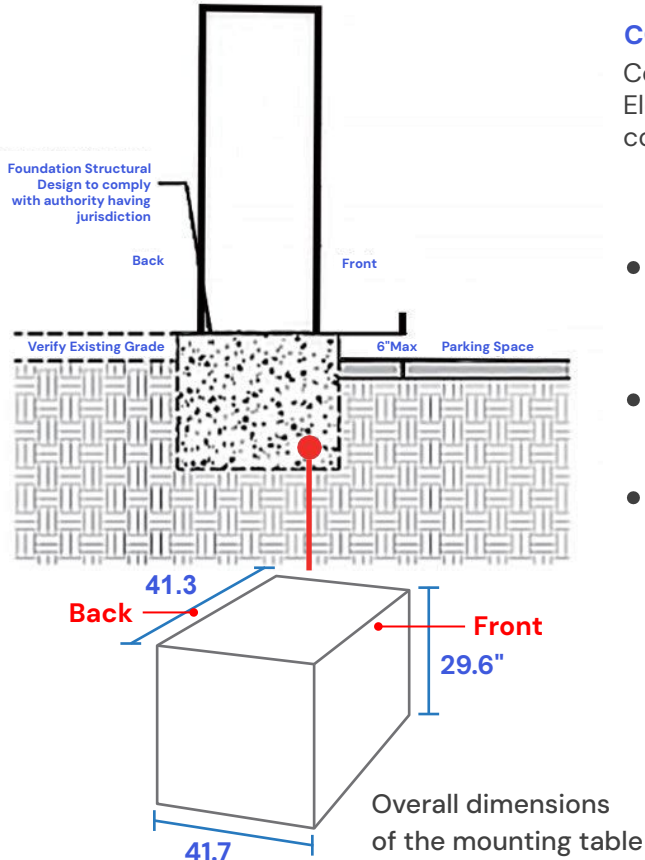

CONCRETE PAD

Concrete pad using 3,000 to 4,000 psi concrete should be used. Electrical for AC power should be positioned such that it exits the concrete pad at the Main AC Power Line Opening.

Important things to note:

- When making the installation platform, a PVC pipe with a diameter of 100mm is pre-buried, and steel wires are reserved in the PVC pipe for the convenience of wiring.
- The reserved position of the PVC pipe corresponds to the position of the cable inlet at the bottom of the charging pile.
- The dimensions of the concrete foundation will need to be determined according to the local jurisdiction. The reference foundation is 23.6" deep below ground, Foundation fabrication uses steel bars in accordance with relevant standards. Recommended 5/8" threaded rebar. The concrete platform should be 6" above ground, any more than 6" will cause the charger to control above the ADA compliance maximum and may cause the inspection to fail and the foundation may need to be lowered to Meets ADA guidelines.

MECHANICAL INSTALLATION (TP5-240-480)

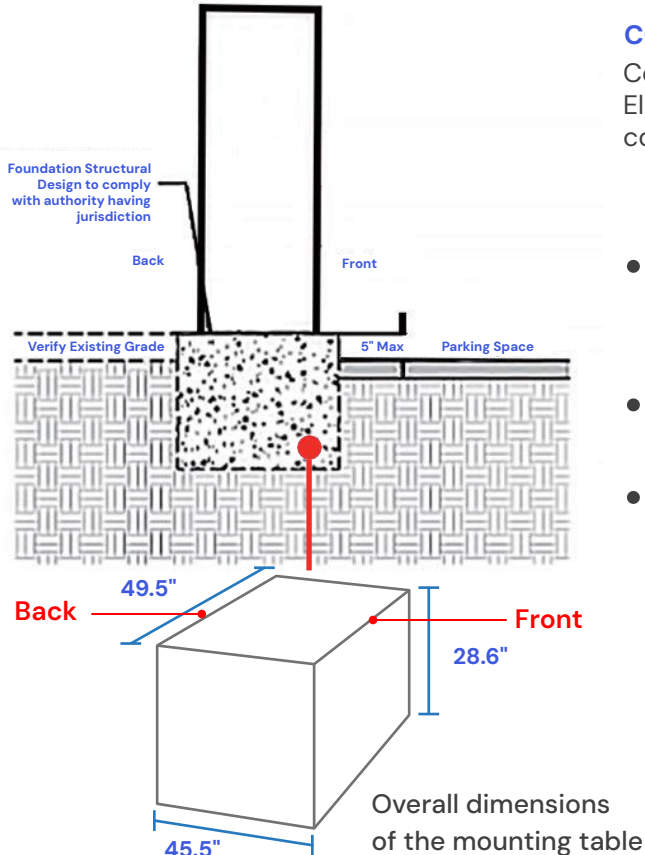

CONCRETE PAD

Concrete pad using 3,000 to 4,000 psi concrete should be used. Electrical for AC power should be positioned such that it exits the concrete pad at the Main AC Power Line Opening.

Important things to note:

- When making the installation platform, a PVC pipe with a diameter of 100mm is pre-buried, and steel wires are reserved in the PVC pipe for the convenience of wiring.
- The reserved position of the PVC pipe corresponds to the position of the cable inlet at the bottom of the charging pile.
- The dimensions of the concrete foundation will need to be determined according to the local jurisdiction. The reference foundation is 23.62" deep below ground, Foundation fabrication uses steel bars in accordance with relevant standards. Recommended 5/8" threaded rebar. The concrete platform should be 1.38" above ground, any more than 1.38" will cause the charger to control above the ADA compliance maximum and may cause the inspection to fail and the foundation may need to be lowered to Meets ADA guidelines.

STEP 1 UNPACK

01. Remove the screws on the front panel, the top front, and all bottom screws.

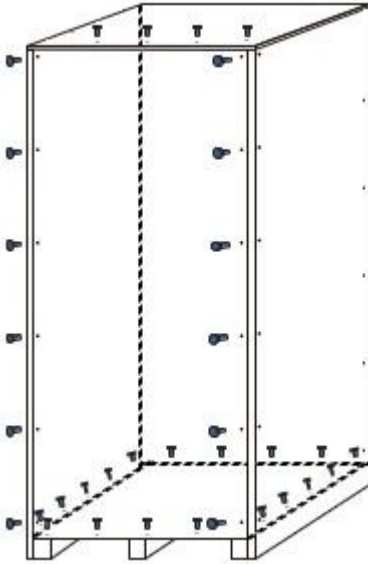

02. Untie the straps that fix the charging station and remove the vacuum bag and plastic film.

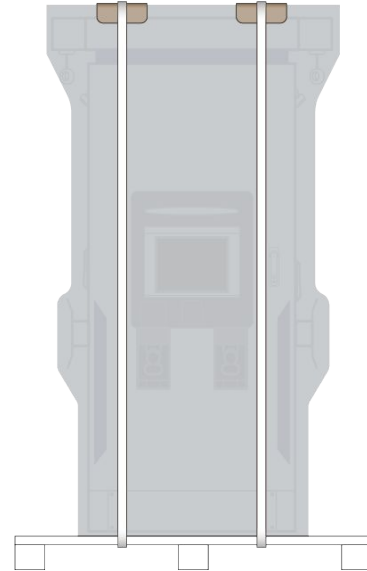

STEP 2 START INSTALLATION (HPC-240-480)

03. Drill holes on the mounting platform according to the bolt hole size at the bottom of the charging station, and pre-install the expansion bolts at the grounding holes.

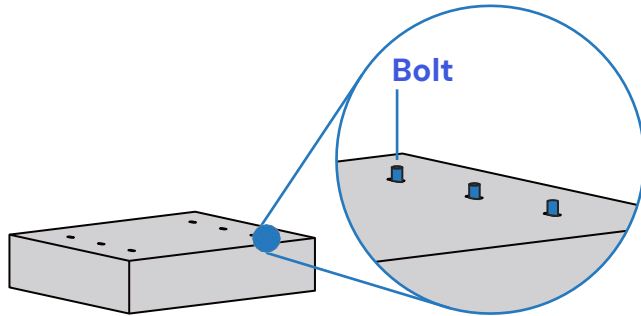

Bolt M14*100 × 6

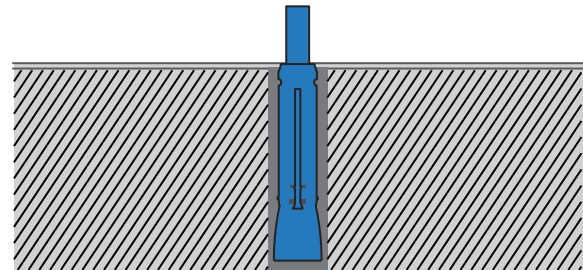
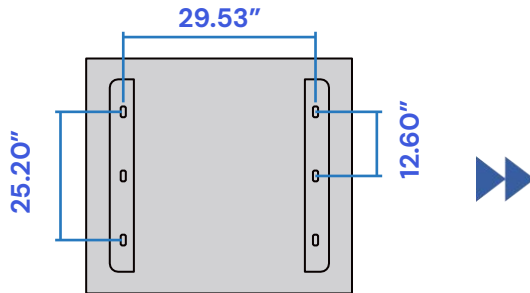
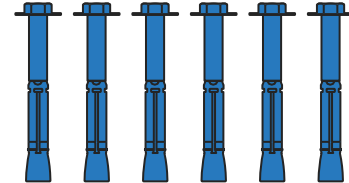

1. The ground holes are 0.71" in diameter and 4.33" – 4.72" in depth.

2. Remove the nut and gasket, and put the expansion bolt body into the hole (as shown in the figure).

STEP 2 START INSTALLATION (TP5-240-480)

03. Drill holes on the mounting platform according to the bolt hole size at the bottom of the charging station, and pre-install the expansion bolts at the grounding holes.

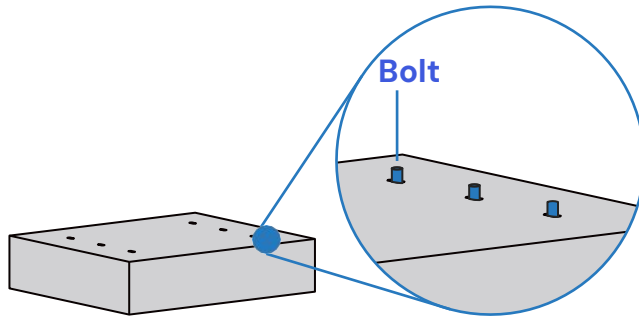

Bolt M14*100 × 6

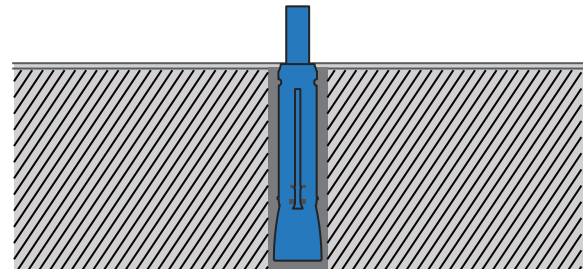
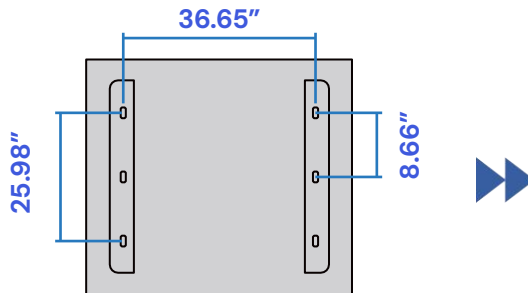
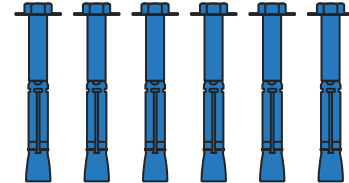

1. The ground holes are 0.71" in diameter and 4.33" – 4.72" in depth.

2. Remove the nut and gasket, and put the expansion bolt body into the hole (as shown in the figure).

STEP 2 START INSTALLATION

04. Use a forklift to move the charging station to the installation site.

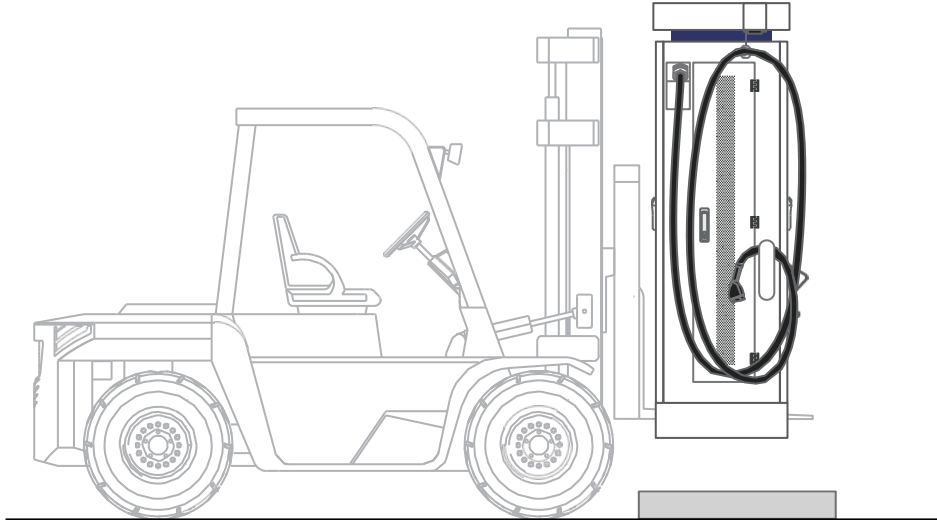

STEP 2 START INSTALLATION

05. Tighten the expansion bolts after placing the charging station at the installation site.

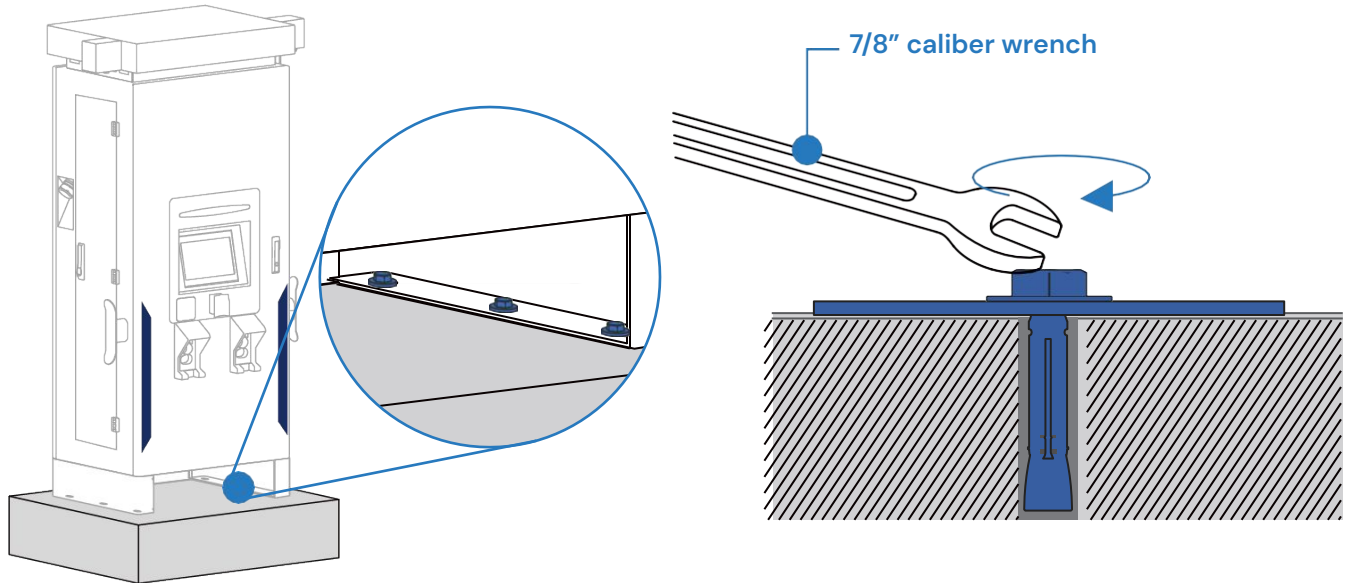

STEP 3 WIRING

06. Open the front door of the charging pile.

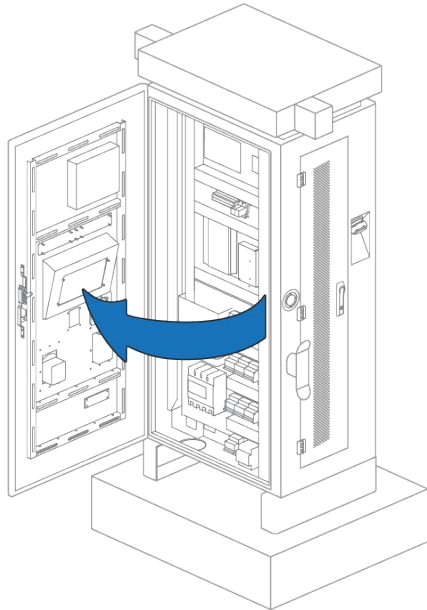

07. Start connecting wires

The incoming line is connected from the power distribution cabinet to the molded case circuit breaker and grounding bar of the charging station. It is recommended to use a 400A circuit breaker with a wire diameter of 600MCM.

Distribution Cabinet

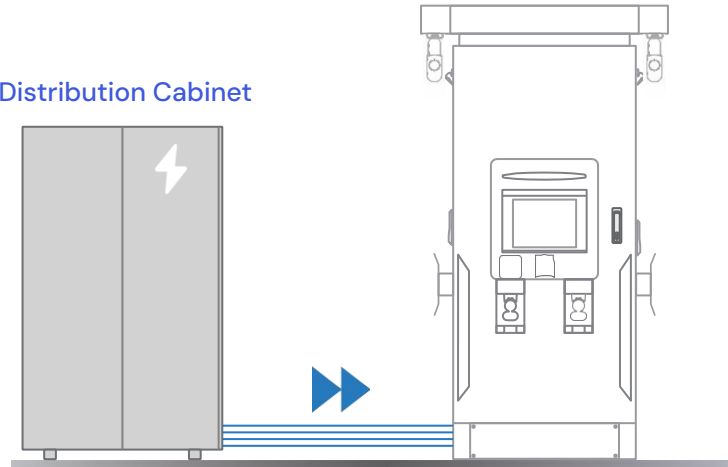

STEP 3 WIRING

08. The inlet wires are connected to the MCCB and the grounding bar through the opening at the bottom of the charging station.

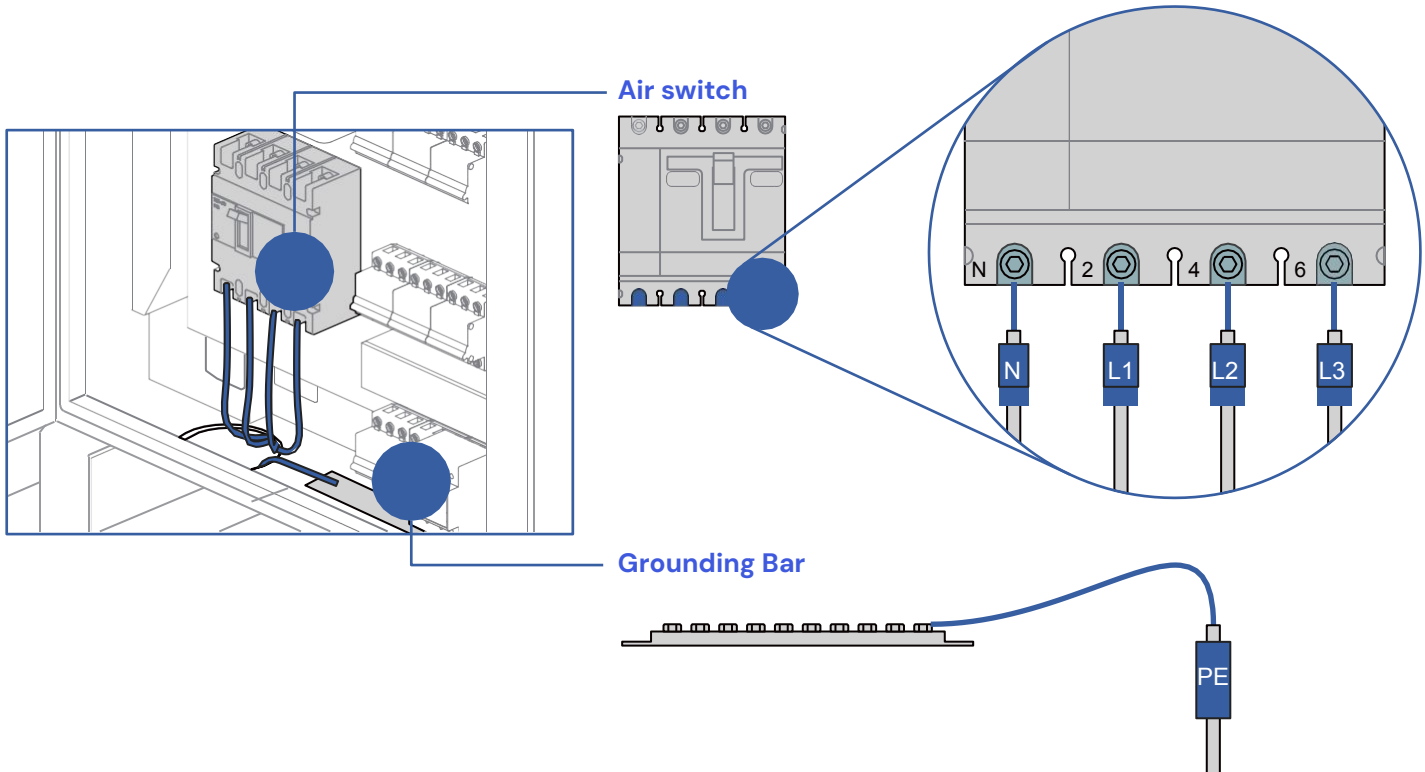

STEP 4 PREPARATIONS BEFORE STARTING

09. Turn on all switches in the charging station.

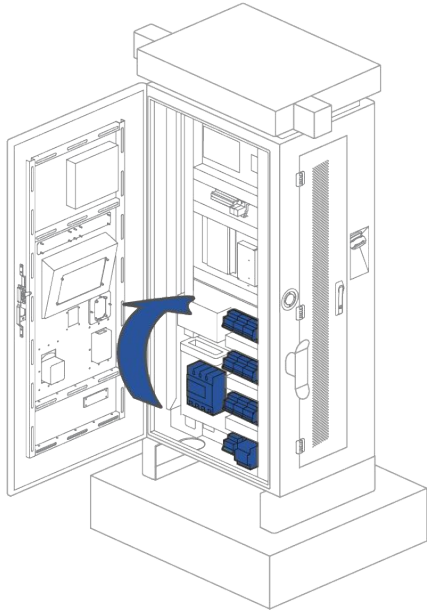

10. Open the door on the left side of the charging station and check if the power module lights up green.

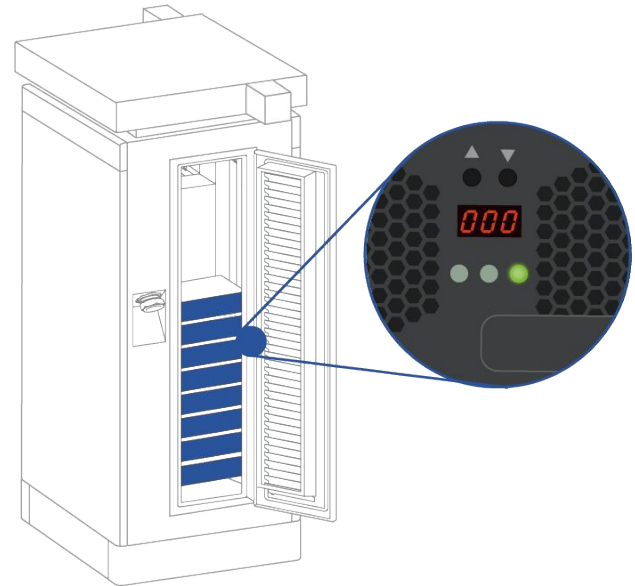

STEP 4 PREPARATIONS BEFORE STARTING

11. Wait for the front panel indicator to change from red to green.



12. Install the front and rear Forklift dampers.

Screws M5 *8

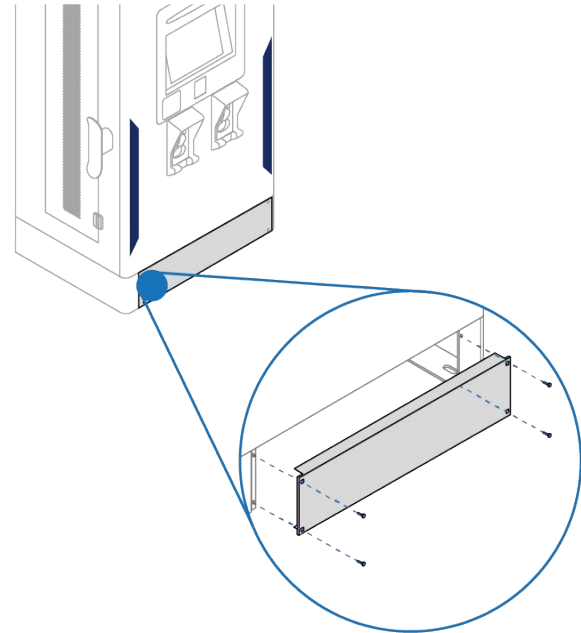



OPERATING INSTRUCTIONS





LED Indicator:

RED / Orange	Fault
Green	Charging
White	Available

- 

This icon indicates the charger is not connected to a server network or loss of internet connectivity. If no network is connected, the station works as a stand-alone device with ChargeTronix RFID cards.
- 

This icon indicates the charger is connected to a server network; it can be authorized with registered RFID cards or mobile app.
- 

The stable icon indicates working condition of the charger. If the icon flashes or not visible on the screen . the controller is inactive.
- 

RFID card reader is active. If the icon is not visible on the screen, the RFID reader is inactive.

CHARGER SETTINGS

SETTING PARAMETERS

During the initial installation, the setting parameters must be set by the manufacturer or the operating partner, or the service partner. Changes may only be made by trained specialist personnel.

01. Click the logo in the upper left corner to enter the login interface.

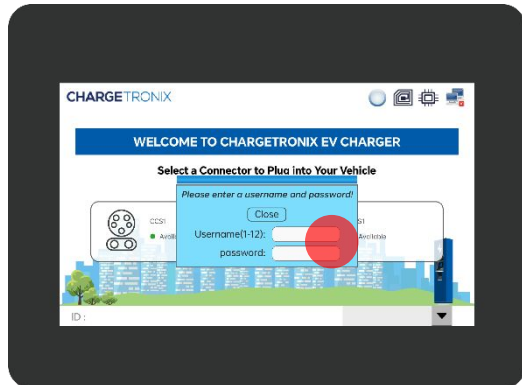

02. Provide the Password. Password will be shared to the authorized representative.

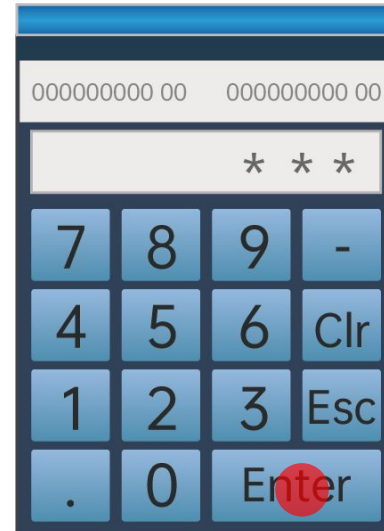

CHARGER SETTINGS

03. Click the logo in the upper left corner to enter the background page.

04. Click "system settings".

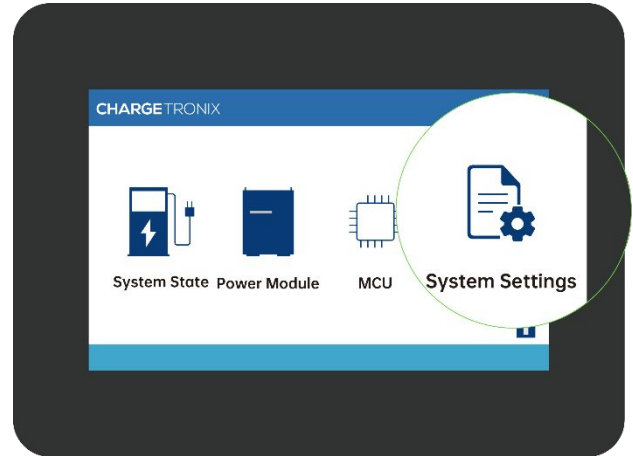
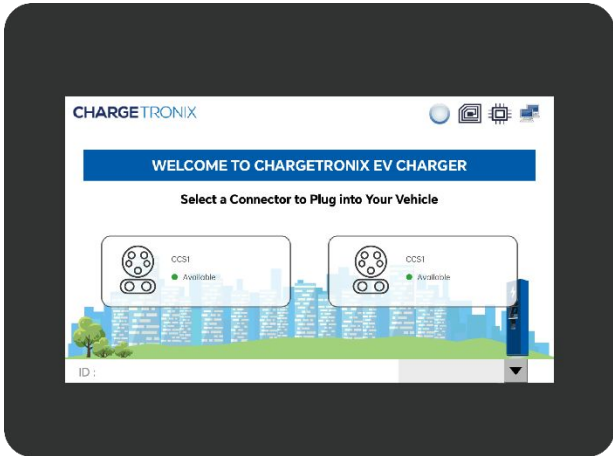

CHARGER SETTINGS

05. Click to set "SERVERURL" and "DEVICEID".

- Address and equipment stake refer to the nameplate of the charging pile
- Keep the address consistent with the equipment stake number

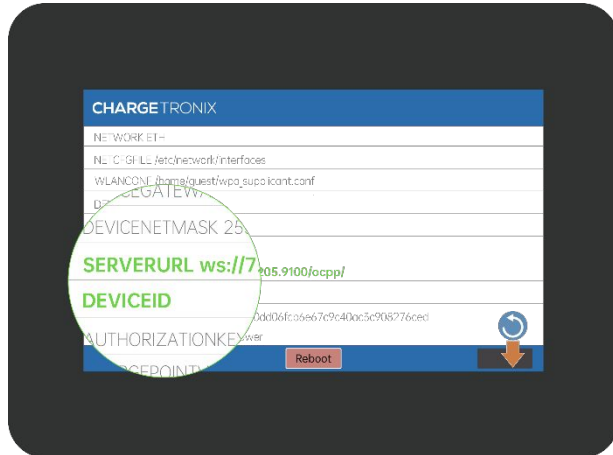

06. Long press the LOGO in the upper left corner to return to the initial interface to check the networking status, and the networking is successful.

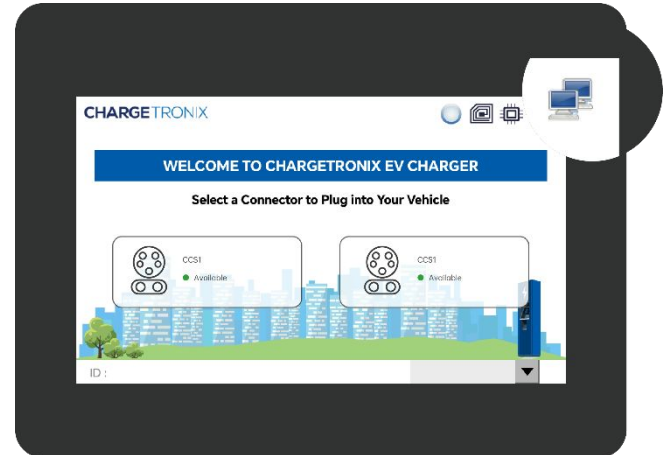

CHARGER SETTINGS

07. Enter the "system settings" page again to set the maximum current power limit.

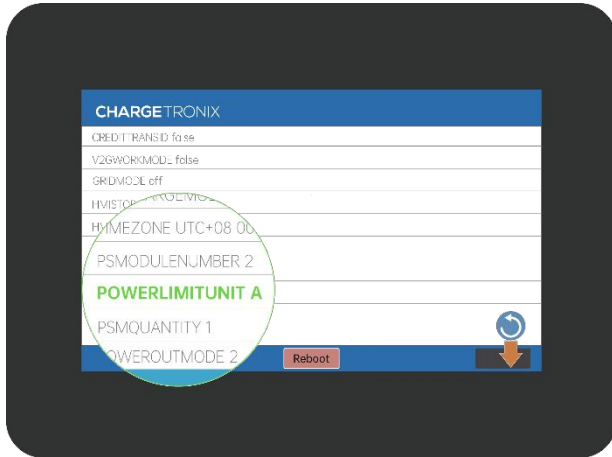

Click "Next Page" to turn to the fifth page



Click "POWERLIMIT UNIT"



two settings

1 Limit current

2 Limit power



Enter the capital letter "A"



Enter the capital letter "W"

CHARGER SETTINGS

08. Set the maximum current power limit. (Set the corresponding parameters according to the grid load)

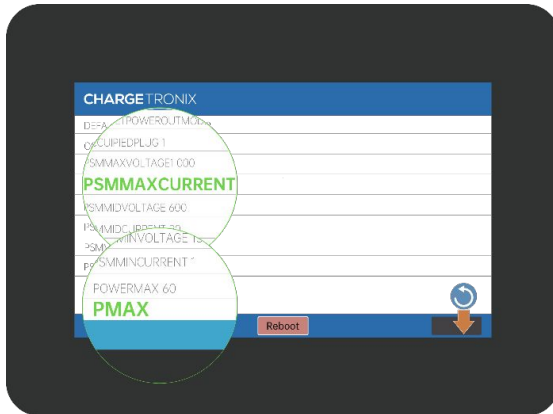

Click "Next Page" to turn to the sixth page



1 Click "PSMMAXCURRENT"----- Set the maximum current

2 Click "PMAX" ----- set maximum power

CHARGER SETTINGS

09. After the parameter setting is completed, click "Reboot" to display the initial interface.

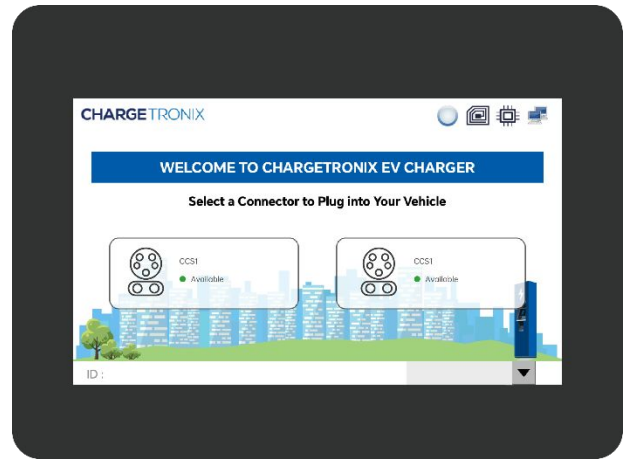
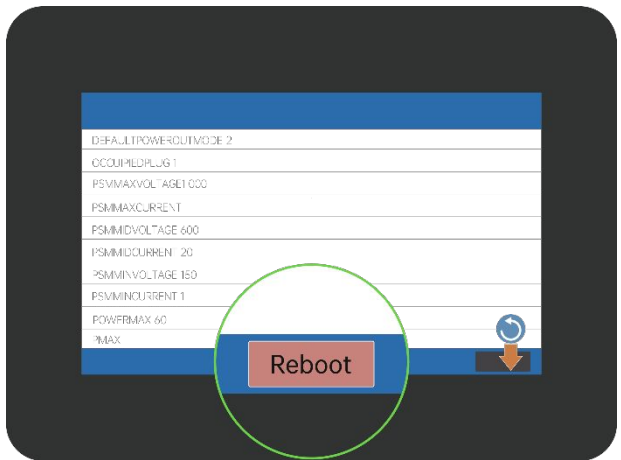

CHARGER SETTINGS

S.NO	PARAMETERS	VALUE	REMARKS
1	NETWORK	ETH	Ethernet-DO NOT CHANGE
2	NETCFGFILE	/etc/network/interfaces	Path- DO NOT CHANGE
3	WLANCONF	/home/guest/wpa_supplicant.conf	Path-DO NOT CHANGE
4	DEVICEIP	192.168.2.13	IP Address of Device
5	DEVICEGATEWAY	192.168.2.1	IP Address of Gateway
6	DEVICENETMASK	255.255.255.0	IP Address of mask
7	SERVERURL	ws://exampleserver.com:9100/ocpp/202006051001	Server Address of OCPP
8	DEVICEID	2020060510	Device ID
9	AUTHORIZATIONKEY	4F43415F4F4354545F61646D696E5F74657374	Authentication code of Server login
10	CHARGEPOINTVENDOR	ChargeTronix	ID of Operator
11	CHARGEPOINTMODEL	DC	Charger Type- DO NOT CHANGE
12	ADPATH	/	NA
13	QRCODENAME	/	NA

CHARGER SETTINGS

S.NO	PARAMETERS	VALUE	REMARKS
14	LANG	en	Path – DO NOT CHANGE
15	MODE	/	NA
16	APN	/	NA
17	CHARGINGPIC	/	NA
18	IDELPIC	/	NA
19	LCM	lcm:1=/dev/ttyS4	Path – DO NOT CHANGE
20	LCMENCODETYPE	UNICODE	Encode –DO NOT CHANGE
21	LCMPASSWD	XXX	Password for access
22	RFID	RFIDO=/dev/ttyS1	Communication Interface of RFID
23	PLUGDCNUMBER	2	The quantity of gun
24	PLUG1	DIN1DC1:3=/dev/ttyS0	Path – DO NOT CHANGE
25	PLUG2	DIN1DC2:3=/dev/ttyS0	Path – DO NOT CHANGE
26	DC1QRCODENAME	/	NA
27	RFIDORIGINALNUMBER	1	Type of RFID data received
28	SFTPHOST	47.94.107.196	Upload Server Address by sftp

CHARGER SETTINGS

S.NO	PARAMETERS	VALUE	REMARKS
29	SFTPUSENAME1	root	Upload Server Username by sftp
30	SFTPPASSWORD	Yue@Peng#ju	Upload Server Password by sftp
31	SFTPPORT	20002	Upload Server Terminal code by sftp
32	ICCID	89882280666023280757	The iccid code of 4G Module
33	IMSI	89882280666023280757	The imsi code of 4G Module
34	METERSERIALNUMBER	/	NA
35	METERTYPE	DC	Type of Meter fits OCPP
36	PLUGINCHARGEMODE	false	charging gun mode configured locally
37	PLUGINCHARGEID	/	NA
38	PLUG&CHARGE	/	NA
39	PLUGINMACIDAUTH	false	PLC MAC certified
40	AUTHREMOETEXREQ	false	Return authentication information
41	SECONDCHARGERMODE	true	Start charging mode selection
42	CREDITTRANSID	false	Use the trans of POS

CHARGER SETTINGS			
S.NO	PARAMETERS	VALUE	REMARKS
43	V2GWORKMODE	false	Work Mode of V2G
44	GRIDMODE	/	NA
45	HMISTOPKEY	1	Press stop key by screen
46	HMICHARGEMODE	1	set up Charging mode by screen
47	CPONAME	OCA	Charging Alliance Organization
48	COMMONNAME	OCATEST	SSL CA Certificate Name
49	LOCALITYNAME	BJ	SSL CA Domain Name
50	ORGANIZATIONALUNITNAME	PD	SSL CA Parameter
51	COUNTRYNAME	CN	SSL CA Parameter
52	STATEORPROVINCENAME	BJ	SSL CA Parameter
53	SERIALNUMBER	/	NA
54	DOMAINCOMPONENT	OCTT	SSL CA Parameter
55	EMAILADDRESS	support@ChargeTronix.com	SSL CA Parameter

CHARGER SETTINGS

S.NO	PARAMETERS	VALUE	REMARKS
56	SECURITYPROFILE	0	Encrypt user password
57	SECURITYKEYLENGTH	2048	Lenth of Secret Key
58	SECURITYKEYTYPE	rsa	Encryption Type
59	SECURITYDIGEST	SHA256	Certificate Summary Complete Verification Rules
60	SECURITYCIPHER	aes256	Certificate encryption type
61	REBOOTSYSTEMENABLE	false	Reboot System
62	TIMEZONE	UTC+08:00	Setting time zone
63	PSMODULENUMBER	2	Quantity of Power Module
64	POWERLIMITUNIT	A / W	Type of Limiting Power: A- current, W-watt
65	PSMQUANTITY	1	Output power current coefficient
66	POWEROUTMODE	/	NA
67	DEFAULTPOWEROUTMODE	2	Default Charging Model
68	OCCUPIEDPLUG	/	NA

CHARGER SETTINGS

S.NO	PARAMETERS	VALUE	REMARKS
69	PSMMAXVOLTAGE	1000	Max Voltage of Power Module
70	PSMMAXCURRENT	350	Max Current of Power Module
71	PSMMIDVOLTAGE	500	General Voltage of Power Module
72	PSMMIDCURRENT	20	General Current of Power Module
73	PSMMINVOLTAGE	205	Min Voltage of Power Module
74	PSMMINCURRENT	1	Min Current of Power Module
75	POWERMAX	160	Max Output Power
76	PMAX	160000	max output power amps or watt
77	PRICETYPE	kwh	Charge Type
78	PPRC	/	NA
79	PKWP	/	NA
80	MINP	/	NA
81	CONST	/	NA

CHARGER SETTINGS

S.NO	PARAMETERS	VALUE	REMARKS
82	SCPT	/	NA
83	COST	/	NA
84	SMARTCHARGETYPE	/	NA
85	CHARGESTATIONMAXPOWER	200000	Max Power of Charger
86	CHARGESTATIONMAXCURRENT	500	Max Current of Charger
87	CHARGEPOINTID	/	NA
88	CHARGEPOINTMAIN	/	NA
89	TCPSERVERPORT	/	NA
90	TCPSERVERIPADDR	/	NA
91	CONNECTOR1MODNUM	2	Model of Connector1
92	CONNECTOR1MAXOU	1000	Max Voltage of Connector1
93	CONNECTOR1MAXOI	300	Max Current or Connector1

CHARGER SETTINGS

S.NO	PARAMETERS	VALUE	REMARKS
94	CONNECTOR1MAXKW	80	Max Power of Connector1
95	CONNECTOR1GUNTEMP	95	Max Gun Temperature of Connector1
96	CONNECTOR1IMD	1	Insulation detection parameters of Connector1
97	CONNECTOR1IMDRES	100	Insulation detection parameters of Connector1
98	CONNECTOR1METER	1	Meter parameters of Connector1
99	CONNECTOR1OUTVOL	60	Output voltage of Connector1
100	CONNECTOR1STICKY	0	Connection detection parameters of Connector1
101	CONNECTOR1PRECHAR	1	Precharge parameters of Connector1
102	CONNECTOR1CHAING	1	Charging parameters of Connector1
103	CONNECTOR2MODNUM	2	Model of Connector2
104	CONNECTOR2MAXOU	1000	Max Voltage of Connector2

CHARGER SETTINGS

S.NO	PARAMETERS	VALUE	REMARKS
105	CONNECTOR2MAXOI	300	Max Current or Connector2
106	CONNECTOR2MAXKW	80	Max Power of Connector2
107	CONNECTOR2GUNTEMP	95	Max Gun Temperature of Connector2
108	CONNECTOR2IMD	1	Insulation detection parameters of Connector2
109	CONNECTOR2IMDRES	100	Insulation detection parameters of Connector2
110	CONNECTOR2METER	1	Meter parameters of Connector2
111	CONNECTOR2OUTVOL	60	Output voltage of Connector2
112	CONNECTOR2STICKY	0	Connection detection parameters of Connector2
113	CONNECTOR2PRECHAR	1	Precharge parameters of Connector2
114	CONNECTOR2CHAING	1	Charging parameters of Connector2
115	CCSNETWORK1	/	NA

CHARGER SETTINGS

S.NO	PARAMETERS	VALUE	REMARKS
116	INSYSPLCMAC1	/	NA
117	CCSNETWORKIP	/	NA
118	CCSNETWORKGATEWAY	/	NA
119	CCSNETWORKNETMASK	/	NA

HOW TO START A CHARGING SESSION

01. Please select the connector compatible to your EV.
Plugin the connector.

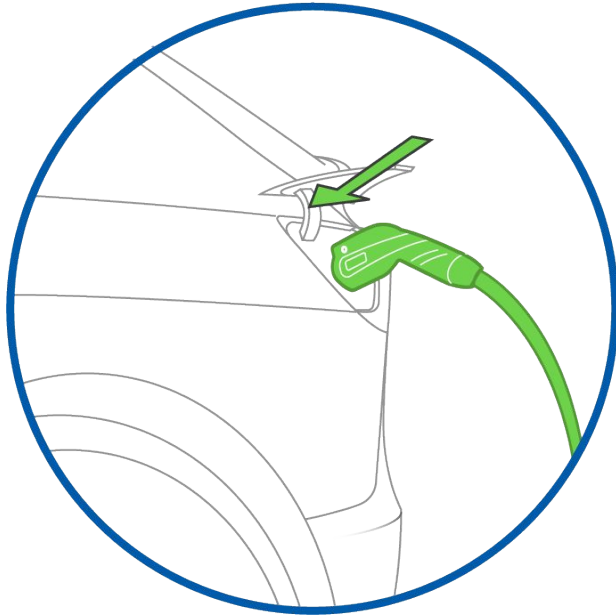

02. After the charging cable is plugged in, it will display "connected", click "connected".

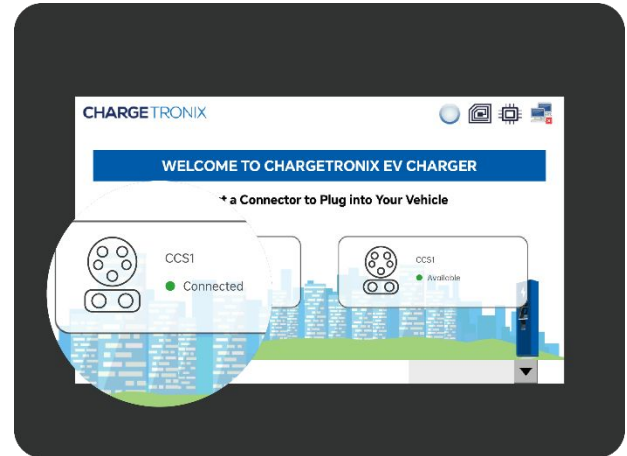

HOW TO START A CHARGING SESSION

03. Select Authorization/Payment Method



RFID CARD

1. Charger display will provide options to select Authorization/Payment Method.
2. Swipe the RFID Card.
3. Charging session will begin within 60 seconds.
4. To stop the charging – Swipe the same RFID card again or use STOP button on screen.

QR CODE /MOBILE APP

1. Charger display will provide options to select Authorization/Payment Method.
2. Scan the QR code or start the charging from Mobile App.
3. Charging session will begin within 60 seconds
4. To stop the charging – Stop from the Mobile App or use STOP button on screen

CREDIT CARD

1. Charger display will provide options to select Authorization/Payment Method.
2. Authorize your credit card. Make sure you have enough balance on the card to charge
3. Charging session will begin within 60 seconds
4. Charging will automatically stop after the 100% charge or use STOP button on screen

During the charging process, a real-time data output of the charging process on the screen appears. At any point of time, charging session can be stopped using Stop button on the screen or Emergency Stop button for emergency uses ONLY.

MAINTENANCE AND SERVICE

DANGER

READ AND FOLLOW THE SAFETY CONCERNS AT THE BEGINNING OF THIS MANUAL BEFORE USING THIS DEVICE.

EV Charging Stations require regular maintenance beyond installation to ensure the charge quality of the vehicle, and the continued value of your electric vehicle. Whether you are installing a personal EV charger, or a public one for use, eventually you will require repair or maintenance services to keep your system working without flaws.

MAINTENANCE PRECAUTIONS

Each of the capacitors in this device have a high voltage for a time after shutting off the input power supply. Allow 1 minute after powering down before servicing internal components.

MAINTENANCE ITEMS

Perform periodic checks every 3 to 6 months based on the site conditions and the usage of the charging station.

1. Check the input voltage and ensure it is within the acceptable limits.
2. Check the Ground / Earth resistance and ensure it is within the acceptable limits
3. Clean the Air Filter periodically
4. Make sure that Power Module lights are solid green ONLY.
5. Ensure the charging cables are not worn out and gun pins are clean.
6. Make sure all the air-cooling fans are working normally.

MAINTENANCE AND SERVICE

VISUAL CHECK ITEMS

1. **Check for abnormal sounds from running fans and power units.** If there is any abnormal sound, please don't make assumptions! Call us for further assistance.
2. **Check for abnormal odor, changes of inner materials, corrosion, anomaly in appearance, etc.,** in this device. If there are any anomalies, please don't make assumptions; call us for further assistance!
3. **Check for dust and dirt in this device regularly.** The air filters on the doors can be removed and cleaned using a vacuum cleaner or air blower. The cabinet can be cleaned using a vacuum cleaner. The dust on the components can be cleaned using a soft cloth. Please pay extra attention while using the vacuum cleaner, it should not apply pressure on the control boards or any components.

REPLACEMENT OF FIXED-LIFE COMPONENTS

To prevent the device from failure due to worn out components, it is necessary to replace the components before they reach the end of their lifespan. Use the following replacement intervals as a guideline for the estimate of the total running time. Please don't make assumptions, call us! for further assistance when you replace the parts.

- Intake and exhaust air filters (if present): Approximately three (3) years. The period depends upon the site conditions.
- Please keep in mind that the replacement interval of each part can vary depending on, for example, the usage environment of the device.

TROUBLESHOOTING

ERROR CODES

If an error occurs, check the nature of the error by referring to following Error Code List and take appropriate actions according to instructions by the manufacturer.

ERROR	DESCRIPTION	POSSIBLE SOLUTION
ERROR FLAG 0	Lightning protection device failure	Check the SPD and GFCI circuit
ERROR FLAG 1	Insulation detection abnormal	The insulation check on the EV has failed. Please try to charge different EV.
ERROR FLAG 2	Abnormal communication between Insulation Monitor and Main Control Board (CM)	Please check the connection between the IM and CM boards. Check the LED lights on the CM and IM
ERROR FLAG 3	Abnormal communication between TR board and CM board	Please check the connection between the tr and cmboards. Check the LED lights on the CM and TR
ERROR FLAG 4	Electronic lock failure	Possible failure of the gun to lock on the EV or the 24v supply voltage
ERROR FLAG 5	Internal use	Reserved
ERROR FLAG 6	Abnormal communication between DC meter and Main Control Board (CM)	Please check the connection between the DC and CM boards. Check the LED lights on the CM and communication lines of DC meter.

TROUBLESHOOTING

FAULT TYPE	SOLUTION
IP address communication failure or Server Communication Failure	Please check the parameter settings interface IP address information, such as the corresponding IP address is not correct, please re-enter the address, restart the charging station
AC input over voltage / under voltage	Please check the AC input side of the voltage is too high or too low, excluding the input exception if there is a fault, and then check the parameters set the interface set the threshold is correct
DC output over voltage / over current	Please check whether the output voltage and current are within the range of parameter settings. If not, please check whether the output voltage, current is too high, or whether the parameter setting is reasonable
Card reader failure	The card reader is incorrectly wired, or the card reader is disabled.
Insulation fault	Please check whether the DC bus insulation is normal.
Monitoring board communication failure	Check whether the monitoring board communication line is correct
Charging gun connection failure	Charging gun connection disconnected, please check whether the charging gun is connected properly.

TROUBLESHOOTING

FAULT TYPE	SOLUTION
The emergency stop button is pressed	Check whether the emergency stop button is pressed, if it is, inspect the charger and if everything is normal, release the emergency button and restore the main breaker.
Charging Session shutdown is not successful	MCU board and power module communication failure. Please press emergency stop button to stop the charging. Check the MCU board and power module CAN communication bus.

CUSTOMER RESPONSIBILITIES

1. To operate the charge station with the required protective devices such as MCBs and switches and proper cables installed.
2. The operator/owner/customer is cautioned that any changes or modifications not approved by ChargeTronix shall void ChargeTronix warranty policy
3. To write an emergency plan that instructs people what to do in case of emergency.
4. To locate and prepare the site as per the instructions laid out in this document.
5. To make sure that there is sufficient space around the charger to carry out any regular maintenance work.
6. To appoint a trained person(s) responsible for the safe maintenance/service of the charge station.
7. Neither ChargeTronix nor any of its affiliates shall be liable to the operator/owner/customer of this product or third parties for damages, losses, costs, or expenses incurred by as a result of: an accident, misuse or abuse of this product or unauthorized modifications, repairs or alterations to this product, or failure to strictly comply ChargeTronix operating and maintenance instructions.

WARRANTY AND SERVICE PLAN

ChargeTronix DC chargers comes with the 2 years parts only standard warranty (actual warranty length is subject to sales contract). However, we offer service plans which covers parts and labor as well for an additional add-on fee. We can train your operators or engineers and equip with basic understanding of the troubleshooting and part replacement to make sure the equipment downtime as well as total cost of ownership is minimized.

WARRANTY TERMS

LIMITED WARRANTY: Subject to the exclusions from warranty coverage set forth below, ChargeTronix warrants that the Product will be free from any defects in materials and/or workmanship (the Limited Warranty) for a period of two year after 30 days from the date of shipment or from date of the initial installation whichever is earlier (the Warranty Period). If the Product becomes defective in breach of the Limited Warranty, ChargeTronix will, upon written notice of the defect received during the Warranty Period, either repair or replace, at the choice of ChargeTronix, the Product if it proves to be defective. ChargeTronix will also pay for shipping charges for the failed part. If the returned part has not failed the customer will pay for shipping charges for the replacement part and the associated returned part. Under this guarantee, ChargeTronix liability is limited to repair or replacement of the product with the same or equivalent, or reconditioned product warranted for the original warranty period. The warranty will not include removal costs, reinstallation costs, loss of charging station revenue, nor loss or damage of any kind whatsoever, whether incidental, consequential, or otherwise.

EXCLUSIONS FROM LIMITED WARRANTY

IMPORTANT: The Limited Warranty and your Product shall not apply to defects, or service repairs, resulting from any of the following:

- Damages due to normal wear and tear to charging cords, connectors, LCD/LED display, Touch Screen, or any product alteration or modification, misuse, abuse, accident, vandalism, acts of nature, power surges, or use of software, parts, or supplies not supplied by ChargeTronix, and causes other than manufacturing defects not covered by the warranty.
- Force Majeure – any occurrence or extraordinary event or circumstance beyond the control of ChargeTronix that is an act of God whether that occurrence is caused by war, riot, storm, (such as hurricane, flooding, earthquake, volcanic eruption, etc.), or other natural forces, including high input voltage from generators or lightning strikes or acts of nature or other causes.
- Any alteration or modification of the Product in any way not approved in writing by ChargeTronix.
- Abuse, damage or otherwise being subjected to problems caused by negligence (including but not limited to physical damage from being struck by a vehicle) or misapplication, or misuse of the Products by customers or end users.
- Any damage to the EV charger cord, unless such damage is caused by a manufacturing defect in the cord or connector assembly.

EXCLUSIONS FROM LIMITED WARRANTY

- Improper site preparation or maintenance that has been improperly installed, operated, handled, or used, including use under conditions for which the product was not designed, use in an unsuitable environment, or use in a manner contrary to the ChargeTronix Installation and Operations Manual or applicable laws or regulations.
- Damage because of accidents, extreme power surge, extreme electromagnetic field.
- Use of the Product with software, interfacing, parts or supplies not supplied by ChargeTronix.
- ChargeTronix disclaims any liability for damage to product, property, or personal injury resulting in whole or in part from improper installation, maintenance, or use that is not in accordance with ChargeTronix installation and maintenance procedures.
- Maintenance or use that is not in accordance with ChargeTronix installation and maintenance procedures that has been subjected to incidental or consequential damage caused by defects of other components of the electrical system.

CONTACT US

This document is Property of ChargeTronix and should not be copied, reproduced, or used as the basis for sale or manufacture of apparatus without the written permission of ChargeTronix.

For any support on installation and commissioning, please contact below:

+(1)949-694-1644
www.chargetronix.com
support@chargetronix.com

3587 Harbor Blvd
Costa Mesa, CA 92626